

## epitex

### C1150D-35

InGaAsP IR LED Chip

#### Outline

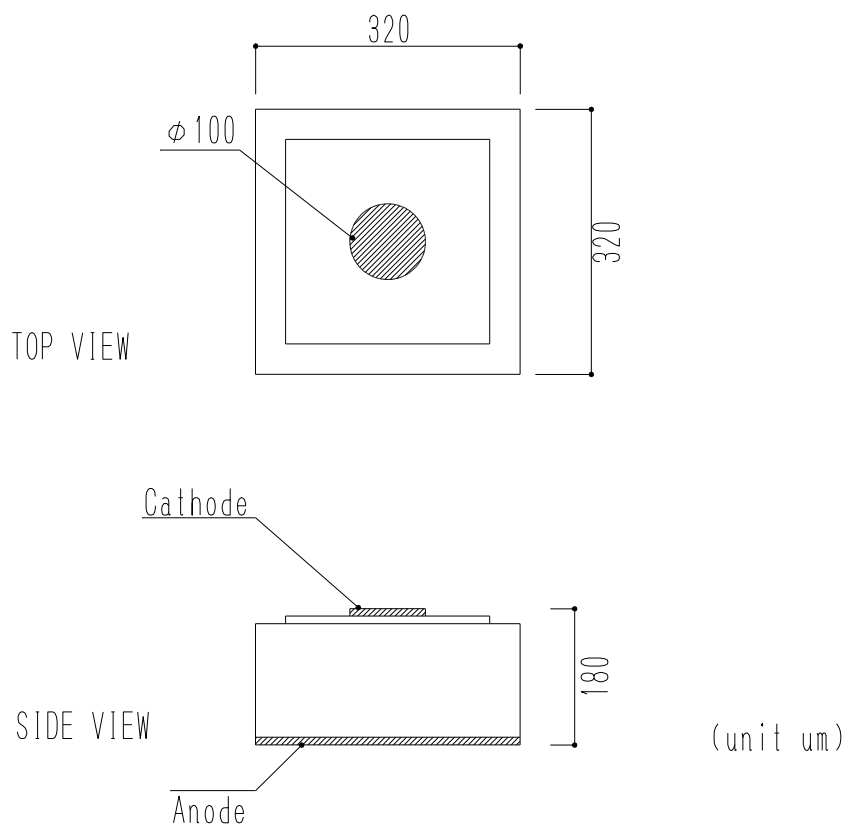

#### Characteristics

- Materials: InGaAsP
- Dimension
  - Chip Size: 320 +/-30 $\mu\text{m}$  x 320 +/-30 $\mu\text{m}$
  - Chip thickness: 180 +/-25 $\mu\text{m}$
  - N bonding pad:  $\phi 100$  +/-10 $\mu\text{m}$
- Bonding pad: Au

## Absolute Maximum Ratings

Item	Symbol	Condition	Ratings	Unit
Forward Current	IF	Ta=25 °C	100	mA
Pulse Forward Current	IFP	Ta=25 °C Duty 1%, Pulse Width 10us	1000	mA
Reverse Voltage	VR	Ta=25 °C	5	V
Junction Temperature	Tj	-	120	°C
Operating Temperature	Topr	-	-40 ~ +100	°C
Storage Temperature	Tstg	Chip	-40 ~ +100	°C
		Chip on Tape	+5 ~ +30	°C

‡ Maximum Ratings are dependent on package.

## Optical and Electrical Characteristics (Tc=25°C)<sup>(1)</sup>

Parameter	Symbol	Condition	Min	Typ	Max	Unit
Forward Voltage	VF1	IF=50mA <sup>(3)</sup>		1.2	1.5	V
	VFP	IFP=1A Duty 1%, Pulse Width 10us		2.5		
Total Radiated Power <sup>(2)</sup>	PO1	IF=50mA <sup>(3)</sup>	5.7	8.2		mW
	POp	IFP=1A Duty 1%, Pulse Width 10us		48		
Reverse Current	IR	VR=5V			10	uA
Peak Wavelength	$\lambda_p$	IF=50mA <sup>(3)</sup>	1120	1150	1180	nm
Spectral Half Width	$\Delta\lambda$	IF=50mA <sup>(3)</sup>		65		nm
Rise Time	tr	IF=50mA		60		ns
Fall Time	tf	IF=50mA		30		ns

(1) Die shall be mounted on TO-18 gold header without resin coated.

(2) Radiated Power is measured by G8370-85.

(3) Applied time is 10msec.

Typical Characteristic Curves

Forward Current - Forward Voltage

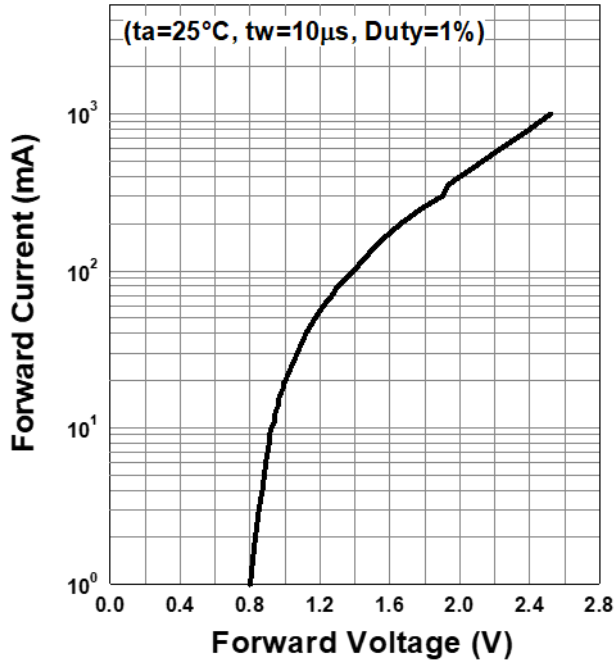

Relative Radiant Intensity - Forward Current

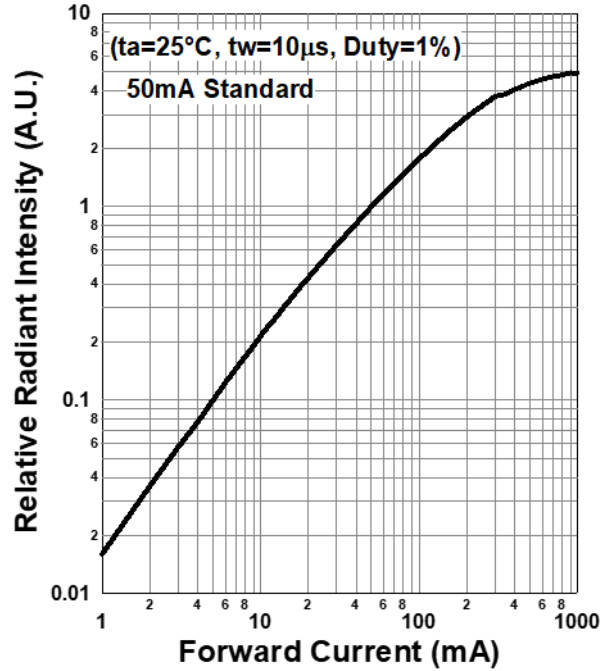

Forward Current - Pulse Duration

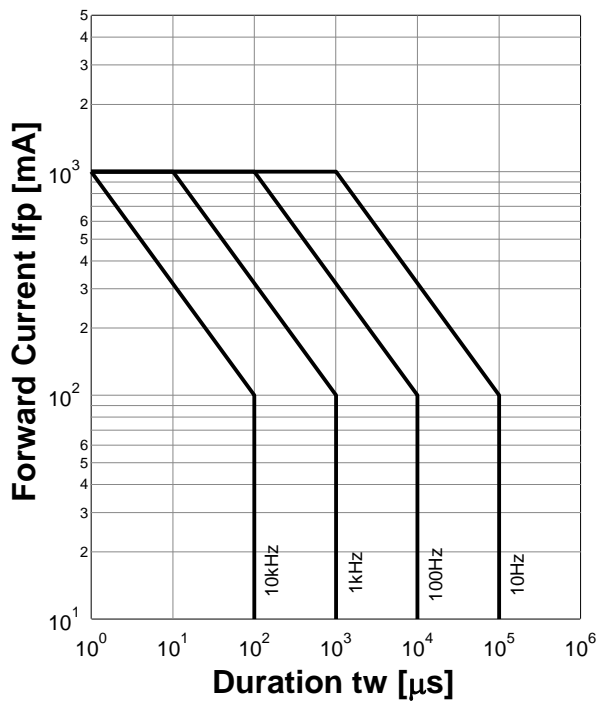

Relative Spectral Emission

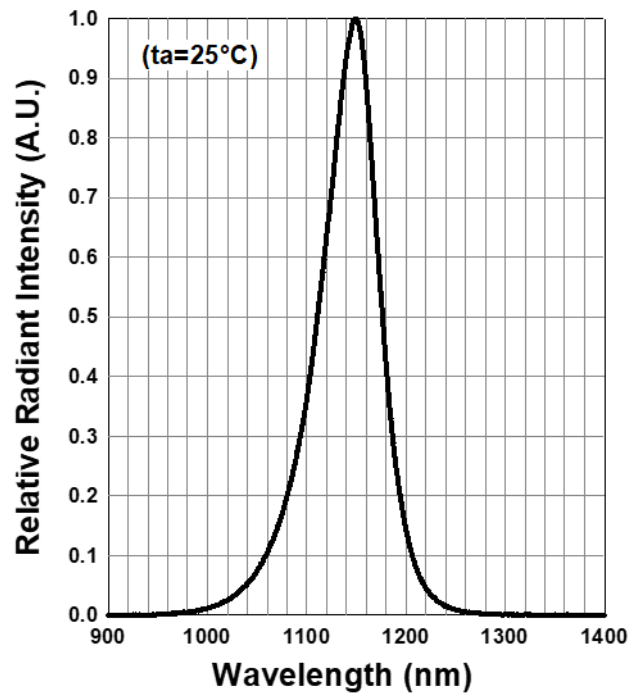

**Forward Voltage - Ambient Temperature**

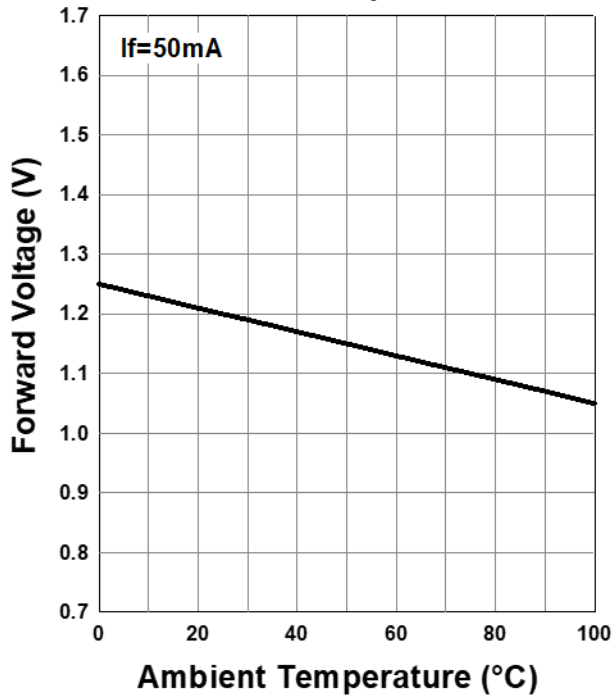

**Relative Radiant Intensity - Ambient Temperature**

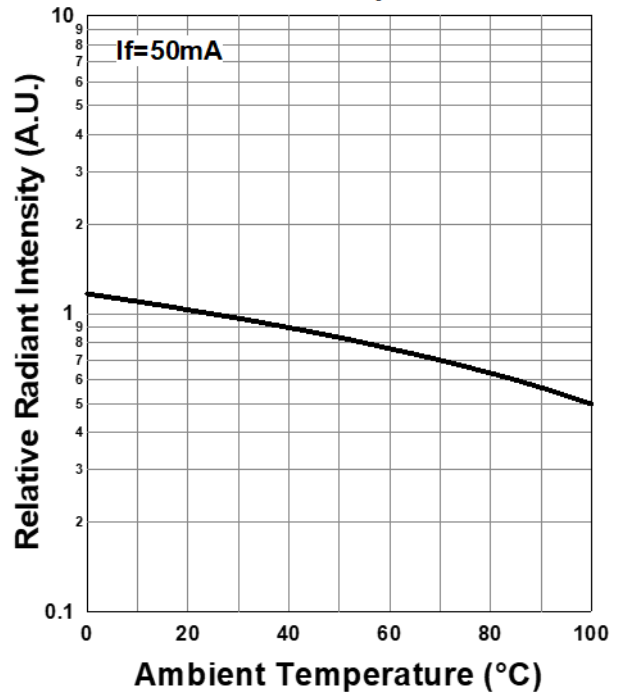

**Peak Wavelength - Ambient Temperature**

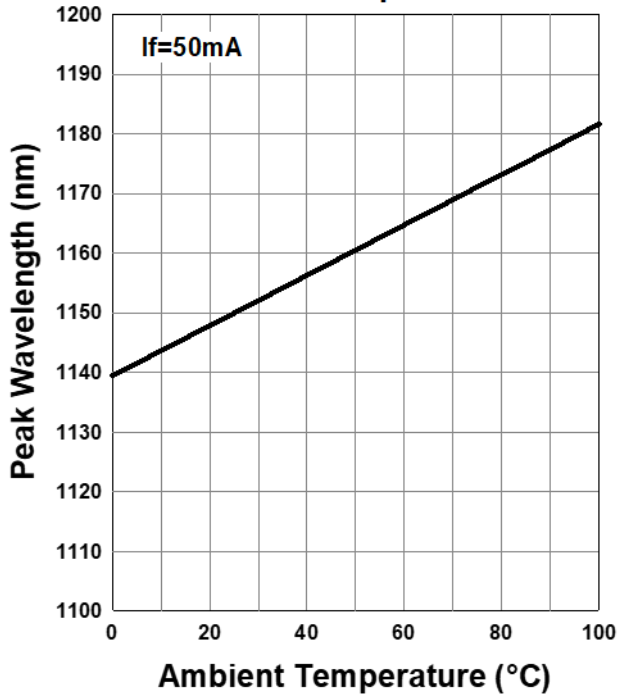

## Disclaimer

Product specifications and data shown in this product catalog are subject to change without notice for the purposes of improving product performance, reliability, design, or otherwise.

Product data and parameters in this catalog are typical values based on reasonably up-to-date measurements.

Product data and parameters may vary by user application and over time.

Products shown in this catalog are intended to be used for general electronic equipment. Products are not guaranteed for applications where product malfunction or failure may cause personal injury or death, including but not limited to life-supporting / saving devices, medical devices, safety devices, airplanes, aerospace equipment, automobiles, traffic control systems, and nuclear reactor control systems.